



- The latest generation of audible and visual alarm devices
- Ex d/Ex e connection chambers
- Audible solutions with directional or omnidirectional horn with up to 120 dB(A) at 1 m, 4 tone channels and 64 preconfigured tones
- Four output levels can be configured
- Brackets and fixings made from stainless steel
- Compliant with EN 54/DNV
- Fastening bracket included

E5

## MY R. STAHL YA60C



The **YA60/3 product series** provides audible alarm signals which can be used to alert, warn or draw attention to equipment malfunction/start-up or any number of safety-related issues in hazardous areas. The preconfigured signal tones provide a wide range of internationally standardised signal patterns, whereby four channels are available for each, enabling flexible use. The signalling devices meet the requirements of EN 54 and DNV for extremely challenging ambient conditions.



	IECEX / ATEX					
Zone	0	1	2	20	21	22
Installation in		•	•		•	•

Selection Table					
Horn version	directional				
Sound pressure level	max. 120 dB(A) @ 1 m				
AC rated operational voltage	Rated operational voltage DC	Product Type	Art. No.	Weight	
110 ... 240 V	133 ... 272 V	YA60/326-PL001-000030-ST000-0000	319423	8.16 kg	
-	12 ... 27.2 V	YA60/326-DL001-000030-ST000-0000	319422	8.05 kg	
Horn version	omnidirectional				
Sound pressure level	max. 114 dB(A) @ 1 m				
AC rated operational voltage	Rated operational voltage DC	Product Type	Art. No.	Weight	
110 ... 240 V	133 ... 272 V	YA60/326-PS001-000030-ST000-0000	322576	6.31 kg	
-	12 ... 27.2 V	YA60/326-DS001-000030-ST000-0000	312375	6.21 kg	

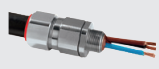
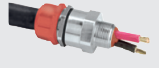

Technical Data	
Explosion Protection	
IECEX gas explosion protection	Ex db eb IIC T6 / T4 Gb
IECEX dust explosion protection	Ex tb IIIC T80 °C / T100 °C Db
ATEX gas explosion protection	⊕ II 2 G Ex db eb IIC T6 / T4 Gb
ATEX dust explosion protection	⊕ II 2 D Ex tb IIIC T80 °C / T100 °C Db
Certificates	ATEX (BVIS), IECEx (BVIS)
Declaration of conformity	ATEX (EUK)
Acoustic Data	
Sound level	4
Ambient Conditions	
Ambient temperature	-40 °C ... 40 °C (T6) -40 °C ... 70 °C (T4)

Technical Data	
Ambient Conditions	
Storage temperature	-60 °C ... 70 °C
Mechanical Data	
IP degree of protection (IEC 60598)	IP66
Enclosure material	Aluminium, powder-coated, Seawater-resistant
Trumpet material	PC/PBT
Max. solid connection terminals	4 mm <sup>2</sup>
Max. finely stranded connection terminals	2.5 mm <sup>2</sup>
Enclosure colour	red, similar to RAL 3020
Mounting / Installation	
Mounting part material	Stainless steel
Connection type	Push in
Components	
Drilled holes	2 x M20 + 2 x M25
Cable glands and entries	1 x M20 Ø 4 ... 13 mm 1 x M25 Ø 7 ... 17 mm
Stopping plugs	2x M20 + 2x M25
Stopping plug material	Polyamide, black

You can find more technical data online at [r-stahl.com](http://r-stahl.com). MY R. STAHL YA60C

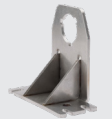
Accessories			
Figure	Description	Art. No.	Weight
Metal cable gland			
	Ex d and Ex e cable gland with compound for all types of armoured cables (SWA, wire-braid, tape) (nickel-plated brass) Type 20PX2K, M20 x 1.5	109428	240 g
	Ex d and Ex e cable glands with RapidEx sealing system for all types of unarmoured cables and wire-braid-armoured cables (nickel-plated brass) Type 20PX2K-REX, M20 x 1.5	246649	240 g
	Ex d and Ex e cable glands with compound for all types of unarmoured cables and wire-braid-armoured cables (nickel-plated brass) Type 20PXSS2K, M20 x 1.5	109441	200 g
	Ex d and Ex e cable glands with RapidEx sealing system for all types of unarmoured cables and wire-braid-armoured cables (nickel-plated brass) Type 20PXSS2K-REX, M20 x 1.5	246605	200 g
Plastic cable gland			
	8161/7-M20-1304, Ex e Polyamide, M20 x 1,5 mm, 4 - 13 mm Lot size 50 pieces	239156	10 g
Stopping plug			
	8290/3-M20 Plastic, M20 x 1.5 Lot size 1 piece	143522	7 g
	8290/3-M20 Plastic, M20 x 1.5 Lot size 100 pieces	285773	500 g

Spare Parts			
Figure	Description	Art. No.	Weight
Mounting accessories			
	L-bracket, stainless steel 1.4404	319271	655 g

Spare Parts			
Figure	Description	Art. No.	Weight
Mounting accessories			
	U-bracket, stainless steel 1.4404	319280	1.55 kg
Shaped horn			
	directional, repair kit	319249	1.01 kg
	omnidirectional, repair kit	319250	625 g

Fastening brackets are included in the delivery as standard.  
 Batch size: Purchase order quantity in [no. of units]; the delivery quantity is automatically rounded to the batch size.

### Dimensional Drawings (All Dimensions in mm [inches]) – Subject to Alterations

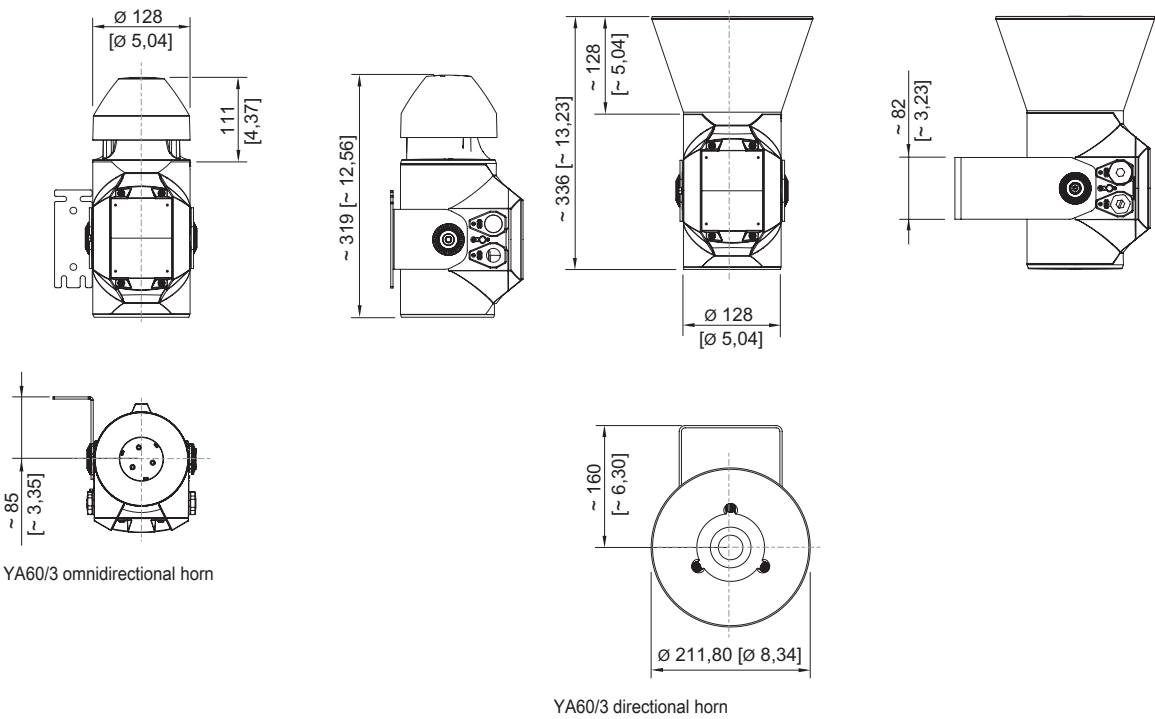

YA60/3 omnidirectional horn

YA60/3 directional horn