

SPX/SPZ SPARTAN



Street Luminaire- Installation Guide

Zone 1 and 21 Variant CML23ATEX3246X & IEC Ex CML23.0094X or CML23UKEX3247X
Zone 2 and 22 Variant CML23ATEX4285X & IEC Ex CML23.0094X or CML23UKEX4286X

This installation guide provides instructions for installing SPARTAN series of explosion protected Street luminaires.

Overview



- 1 Safety Instructions
- 2 Installation
- 3 Maintenance
- 4 Technical Specification
- 5 Declaration of Conformity

Important information

The SPARTAN series of explosion protected luminaires are specialist devices, certified for use in specific operating environments.

The units must be installed in accordance with these instructions, must be correctly certified for the specific operating environment and must be installed by suitably qualified personnel.

If you have any queries about the installation or the certification of the unit - please contact Raytec for immediate assistance and advice.

1. Safety instructions

1. Read this leaflet carefully before commencing to install the SPARTAN unit and retain it for future use. Installation can only be carried out by suitably qualified personnel.
2. Check the certification to ensure that the hazardous zone, mains supply, ambient temperature present and 'T' rating are suitable for the environment the unit is being installed in.
3. **Special Conditions of Use** - Equipment must only be installed in a position that satisfies a low risk of mechanical danger from impact. (4 J)
4. If the SPARTAN unit is to be installed in areas of high vibration, please consult with Raytec.
5. Externally the SPARTAN unit housing is constructed from marine grade aluminium, and toughened glass, stainless steel brackets/fasteners and silicone gaskets, internally there are many non metallic components. The end user must ensure that these materials are suitable for the environment the SPARTAN unit will be installed in; Zone 1 and Zone 2 Hazardous areas.
6. When the unit is installed correctly and in accordance with these installation instructions it will not harm humans or animals.

Max weight 7kg

Projected Area 0.032m² MAX

Max mounting height 15m

Class 1

Eye Safety : Caution – EN62471 Risk Group 2 Classification - The luminaire should be positioned so that prolonged staring into the luminaire at a distance closer than 2.5m is not expected

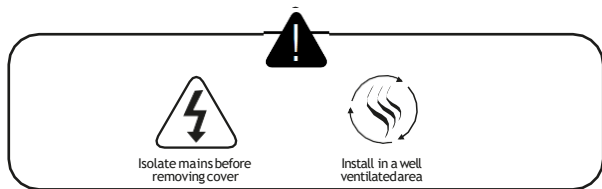

2. Installation

Mounting SPARTAN Unit

1. To meet the requirements of certification a MINIMUM of 2 fixing points must be used, the fixing points must be suitable for the conditions of use. The product is supplied with 2xM8 grub screws for mounting (see point 4 and 5)
2. The line diagrams below are for guidance only

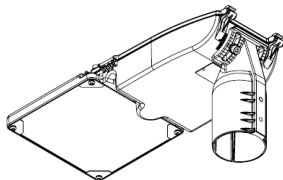
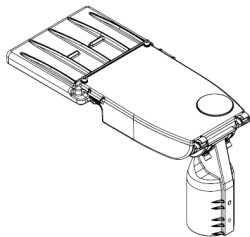
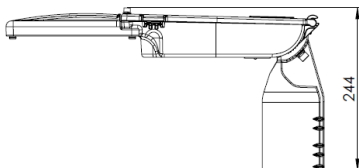
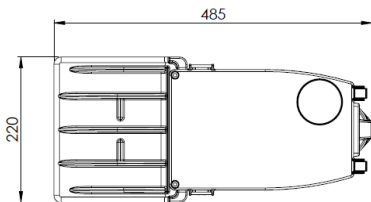

Typical wiring diagram - Standard Variants

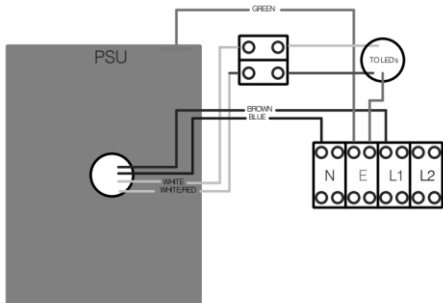

3. The SPARTAN Street is delivered in two parts; the main body of the luminaire, and the pole mount arm. These two parts must be assembled prior to installation.
4. Luminaire and Pole Mount Bracket Assembly



5.
 - Feed the supply cable through the pole mount arm before securing it to the luminaire's main body.
 - The pole mount arm can be assembled in a vertical orientation, with an angle range to the vertical, or in a horizontal orientation, with an angle range to the horizontal.
 - Align the pole mount arm to the back of the main luminaire and locate the two mounting slots on either side.
 - Secure by using the M8 fixings, M8 flat washer, M8 serrated washer and M8 spring washer (one on each side) and tighten to torque 17Nm. (the spring washer is located between the M8 washer and the head of the M8 fixing), (the serrated washer is located between the flat washers and the pole mount casting.)

- Mechanical installation
 - Mount unit on an appropriately sized pole.
 - Secure unit onto pole using supplied grub screws. Ensure pole is fully engaged and tighten grub screws to torque 17nm (5mm hex).

WARNING:

If the factory fitted cable is damaged it must be replaced by a suitably qualified person to avoid a hazard. The light source contained in this luminaire shall only be replaced by the manufacturer or a nominated representative.

- Electrical connection, connect mains supply cable to mains supply at base of column.
- If the unit is opened for any reason, disconnect mains
- If carrying out Insulation Resistance tests the normal method of insulation testing is to connect Live and Neutral together and test between this point and Earth to prevent the risk of damage to the electronic control gear.

Protection Concepts

Zone 1 and 21 Variant CML23ATEX3246X & IEC Ex CML23.0094X or CML23UKEX3247X

II2 GD Ex eb mb IICT4 Gb

Ex tb IIIC T80°C Db

-40°C to +50°C

IP66

110V-254V AC

Zone 2 and 22 Variant CML23ATEX4285X & IEC Ex CML23.0094X or CML23UKEX4286X

II3 GD Ex ec mc IICT4 Gc

Ex tc IIIC T80°C Dc

-40°C to +50°C

IP66

110V-254V AC

3. Maintenance

- It is essential that all SPARTAN units are maintained in accordance with the requirements of the EN60079-17 standard: (Electrical apparatus for explosive gas atmospheres - other than mines).
- IMPORTANT.** No modifications are permitted to the unit, all spare parts must be purchased from the manufacturer, unauthorized modifications or spare parts will invalidate certification and make the equipment dangerous.
- Isolate the SPARTAN unit from the mains supply and allow to cool before carrying out any maintenance work.
- The unit has one power supply; in the event that a power supply needs to be replaced open the terminal enclosure cover to get access to the power supply. Remove the power supply from the mains terminals then remove LED wires (white and white with red mark).
- Disposal of packaging, SPARTAN units and old LED assemblies/power supplies should be carried out in accordance with national regulations.

4. Technical Specification

Input Voltage	110-254V AC
Input Current (230Vac, full load)	0.26A
Consumption	53W
Power Factor (230Vac, full load)	>0.97
Mains Frequency	50/60Hz
Inrush Current (I_{peak} @50%)	23A, $\Delta t < 136\mu s$
Total Harmonic Distortion (230Vac, full load)	< 10%
IP Rating	IP66
Weight (std)	6Kg
Dimensions	See previous pages for line diagrams
ATEX and IECExRating	See above

Inrush Current Typical Curve

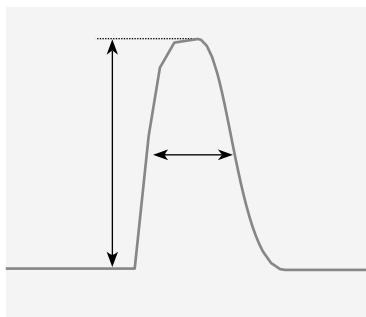

Max number of fittings allowed per MCB

MCB Type	Rating	
B	10A	18
B	16A	29
B	20A	36
B	25A	45
C	10A	30
C	16A	49
C	20A	61
C	25A	76

Declaration Of Conformity With The Atex Directive 2014/34/EU & UK Directive SI 2016 No. 1107 (as amended)



Raytec Ltd. declares under our sole responsibility that the product(s) listed below conform with the relevant provisions of directive 2014/34/EU of 20th April 2016 and UK Directive SI 2016 No. 1107 (as amended)

Manufacturer	Raytec Ltd Unit 15, Wansbeck Business Park Rotary Parkway Ashington Northumberland NE63 8QW United Kingdom	
Description of Equipment	SPARTAN series of Street luminaires	
Certification Body	CML New Port Road Ellesmere Port CH65 4LZ	
Certificate numbers	Zone 1/21 Variant CML23ATEX3246X & IEC Ex CML23.0094X or CML23UKEX3247X Zone 2/22 Variant CML23ATEX4285X & IEC Ex CML23.0094X or CML23UKEX4286X ATEX Quality Assurance Notification CSA BV (2813) UKAS Quality Assurance Notification CSA UK (0518) SIRA21UKQAN0003	
Equipment Marking	Zone 1/21 Variants II 2 GD Ex eb mb IIC T4 Gb Ex tb IIIC T80°C Db -40 °C to +50 °C IP66 110V-254V AC	Zone 2/22 Variants II 3 GD Exec mc IIC T4 Gc Ex tc IIIC T80°C Dc -40 °C to +50 °C IP66 110V-254V AC

Compliance with the Essential Health and Safety Requirements has been assessed by reference to the following harmonised/designated standards -

IEC EN 60079-0 : 2018

EN 60079-18 : 2015 + A1 : 2017

IEC EN 60079-7 : 2015 + A1 : 2018

EN 60079-31:2014

And also 2014/35/EU - Low Voltage Directive, 2014/30/EU - EMC Directive

Signed

Name
Position

Barry Thompson
Director

Dated

Serialnumber



Raytec Global (excluding Americas)

Tel: +44 (0) 1670 520055
sales@raytecd.com

Raytec Ltd.
Unit 15 Wansbeck Business Park, Rotary Parkway
Ashington, Northumberland, NE63 8QW, United Kingdom

raytecd.com

Raytec Americas

Tel: +1 613 270 9990
ussales@raytecd.com

Raytec Systems Inc.
800-300 Terry Fox Drive, Ottawa, Ontario
2K 0E3, Canada